

elements
waterjet collection



MARBLE SYSTEMS



floor / wall tiles



XET02001 ruffle - S.O.*
 snow white polished - black honed
 6 15/32"x6 15/32"x3/8"
 tier 1*: XET02005 *(S.O.)
 tier 2*: XET02004 *(S.O.)
 tier 3*: XET02002 *(S.O.)
 tier 4*: XET02003 *(S.O.)
 0.26 sqft/pcs

XET02008 ruffle
 snow white honed - black honed
 0.26 sqft/pcs
 in stock



XET02009
 ruffle
 snow white polished
 6 15/32"x6 15/32"x3/8"
 0.26 sqft/pcs
 in stock



XET10001 oragami - in stock
 snow white polished
 5 29/32"x7 1/16"x3/8"
 tier 1*: XET10005 *(S.O.)
 tier 2*: XET10004 *(S.O.)
 tier 3*: XET10002 *(S.O.)
 tier 4*: XET10003 *(S.O.)
 0.19 sqft/pcs



XET01001 amulet - S.O.*
 black honed
 5 7/16"x5 7/16"x3/8"
 tier 1*: XET01005 *(S.O.)
 tier 2*: XET01004 *(S.O.)
 tier 3*: XET01002 *(S.O.)
 tier 4*: XET01003 *(S.O.)
 0.15 sqft/pcs



XET01007
 amulet
 snow white polished
 5 7/16"x5 7/16"x3/8"
 0.15 sqft/pcs
 in stock



XET12001 gibraltar - in stock
 snow white polished - snow white honed
 4 1/32"x5 3/8"x3/8"
 tier 1*: XET12005 *(S.O.)
 tier 2*: XET12004 *(S.O.)
 tier 3*: XET12002 *(S.O.)
 tier 4*: XET12003 *(S.O.)
 0.15 sqft/pcs

*S.O. - Special Order. Lead times may vary 2-4 weeks on product.

To view customizable tier options, please refer to our custom patterns program at www.marblesystems.com/custom-patterns/.



floor / wall tiles

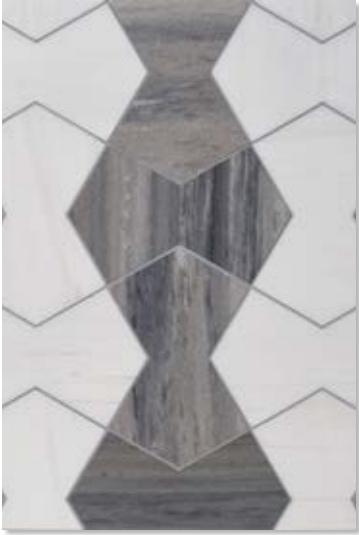

XET08001 cravat - *(S.O.)
 snow white honed - skyline renaissance
 skyline honed
 4 3/4"x7 15/32"x3/8"
 tier 1*: XET08005 *(S.O.)
 tier 2*: XET08004 *(S.O.)
 tier 3*: XET08002 *(S.O.)
 tier 4*: XET08003 *(S.O.)
 0.15 sqft/pcs



XET11001 onda - S.O.*
 glacier honed - allure honed
 5"x8 9/32"x3/8"
 tier 1*: XET11005 *(S.O.)
 tier 2*: XET11004 *(S.O.)
 tier 3*: XET11002 *(S.O.)
 tier 4*: XET11003 *(S.O.)
 0.20 sqft/pcs



XET06001 aurora - S.O.*
 skyline renaissance - skyline honed
 snow white polished - allure polished
 4 7/8"x7 7/8"x3/8"
 tier 1*: XET06005 *(S.O.)
 tier 2*: XET06004 *(S.O.)
 tier 3*: XET06002 *(S.O.)
 tier 4*: XET06003 *(S.O.)
 0.18 sqft/pcs



XET08006
 cravat
 snow white polished
 4 3/4"x7 15/32"x3/8"
 0.15 sqft/pcs
 in stock



XET11008
 onda
 snow white polished
 5"x8 9/32"x3/8"
 0.20 sqft/pcs
 in stock



XET06006
 aurora
 snow white polished
 4 7/8"x7 7/8"x3/8"
 0.18 sqft/pcs
 in stock

*S.O. - Special Order. Lead times may vary 2-4 weeks on product.
 To view customizable tier options, please refer to our custom patterns program at www.marblesystems.com/custom-patterns/.

floor / wall tiles



XET05001 honey comb - S.O.*
 snow white polished - skyline renaissance - skyline honed
 4 27/32"x8 13/32"x3/8"
 tier 1*: XET05005 *(S.O.)
 tier 2*: XET05004 *(S.O.)
 tier 3*: XET05002 *(S.O.)
 tier 4*: XET05003 *(S.O.)
 0.21 sqft/pcs



XET13001 diamante - S.O.*
 skyline renaissance - snow white honed
 4 1/32"x7 1/2"x3/8"
 tier 1*: XET13005 *(S.O.)
 tier 2*: XET13004 *(S.O.)
 tier 3*: XET13002 *(S.O.)
 tier 4*: XET13003 *(S.O.)
 0.10 sqft/pcs



XET05006
 honey comb
 snow white polished
 4 27/32"x8 13/32"x3/8"
 0.21 sqft/pcs
 in stock



XET13006
 diamante
 snow white polished
 4 1/32"x7 1/2"x3/8"
 0.10 sqft/pcs
 in stock

*S.O. - Special Order. Lead times may vary 2-4 weeks on product.
 To view customizable tier options, please refer to our custom patterns program at www.marblesystems.com/custom-patterns/.

floor / wall tiles



XET07001 freccia - S.O.*
skyline honed - skyline renaissance
allure honed
3"x4 29/32"x3/8"
tier 1*: XET07005 *(S.O.)
tier 2*: XET07004 *(S.O.)
tier 3*: XET07002 *(S.O.)
tier 4*: XET07003 *(S.O.)
0.10 sqft/pcs



XET07008
freccia
snow white polished
3"x4 29/32"x3/8"
0.10 sqft/pcs
in stock

freccia single piece layout ideas:

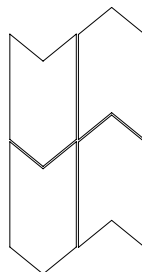

layout option 1

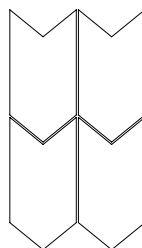

layout option 2

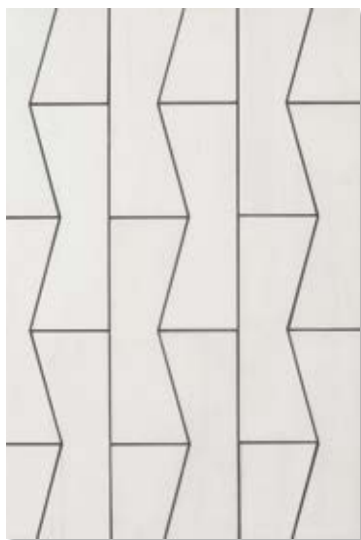

XET04001 ubiquity - in stock
snow white polished - snow white honed
2 29/32"x8 11/32"x3/8"
tier 1*: XET04005 *(S.O.)
tier 2*: XET04004 *(S.O.)
tier 3*: XET04002 *(S.O.)
tier 4*: XET04003 *(S.O.)
0.13 sqft/pcs

ubiquity single piece layout ideas:

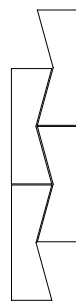

layout option 1
(shown in ubiquity image on the left)

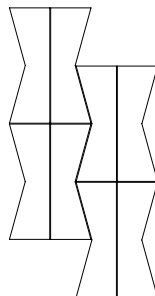

layout option 2

*S.O. - Special Order. Lead times may vary 2-4 weeks on product.

To view customizable tier options, please refer to our custom patterns program at www.marblesystems.com/custom-patterns/.



floor / wall tiles



XET03001 ravel - S.O.*
 black honed - snow white polished - glacier honed
 3 17/32"x6 1/8"x3/8"
 tier 1*: XET03005 *(S.O.)
 tier 2*: XET03004 *(S.O.)
 tier 3*: XET03002 *(S.O.)
 tier 4*: XET03003 *(S.O.)
 0.15 sqft/pcs



XET03006
 ravel
 snow white polished
 3 17/32"x6 1/8"x3/8"
 0.15 sqft/pcs
 in stock

ravel single piece layout ideas:

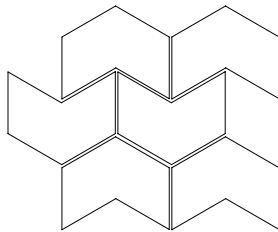

layout option 1

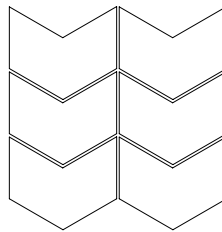

layout option 2

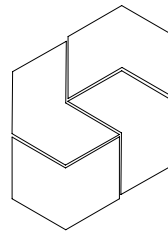

layout option 3
 (shown in ravel image on the left)

*S.O. - Special Order. Lead times may vary 2-4 weeks on product.
 To view customizable tier options, please refer to our custom patterns program at www.marblesystems.com/custom-patterns/.



technical drawings

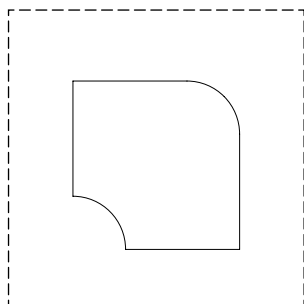

ruffle
 $6 \frac{15}{32}'' \times 6 \frac{15}{32}'' \times \frac{3}{8}''$
 coverage: 0.26 sqft/pcs

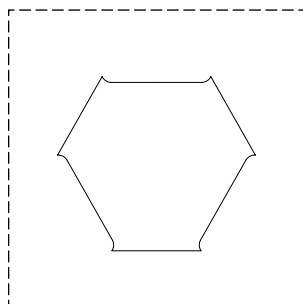

oragami
 $5 \frac{29}{32}'' \times 7 \frac{1}{16}'' \times \frac{3}{8}''$
 coverage: 0.19 sqft/pcs

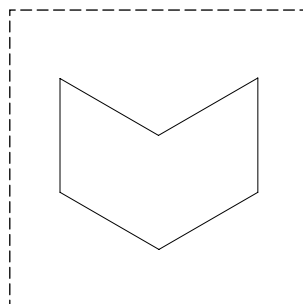

ravel
 $3 \frac{17}{32}'' \times 6 \frac{1}{8}'' \times \frac{3}{8}''$
 coverage: 0.15 sqft/pcs

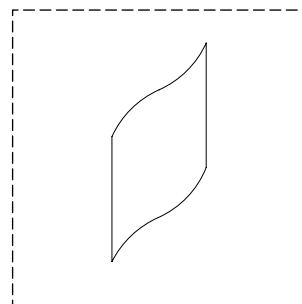

gibraltar
 $4 \frac{1}{32}'' \times 5 \frac{3}{8}'' \times \frac{3}{8}''$
 coverage: 0.15 sqft/pcs

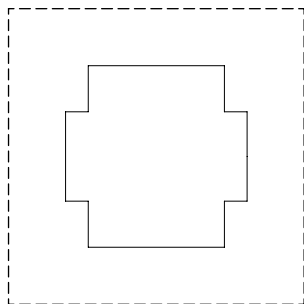

amulet
 $5 \frac{7}{16}'' \times 5 \frac{7}{16}'' \times \frac{3}{8}''$
 coverage: 0.15 sqft/pcs

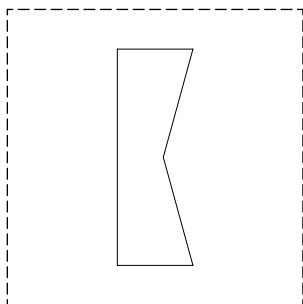

ubiquity
 $2 \frac{29}{32}'' \times 8 \frac{11}{32}'' \times \frac{3}{8}''$
 coverage: 0.13 sqft/pcs

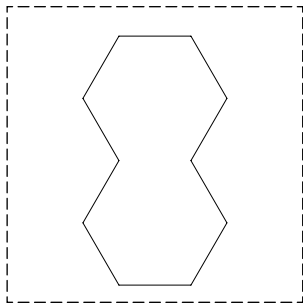

honey comb
 $4 \frac{27}{32}'' \times 8 \frac{13}{32}'' \times \frac{3}{8}''$
 coverage: 0.21 sqft/pcs

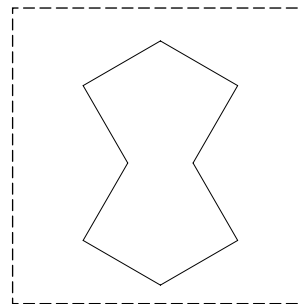

cravat
 $4 \frac{3}{4}'' \times 7 \frac{15}{32}'' \times \frac{3}{8}''$
 coverage: 0.15 sqft/pcs

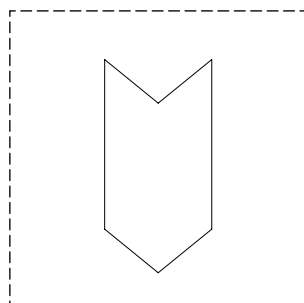

freccia
 $3'' \times 4 \frac{29}{32}'' \times \frac{3}{8}''$
 coverage: 0.10 sqft/pcs

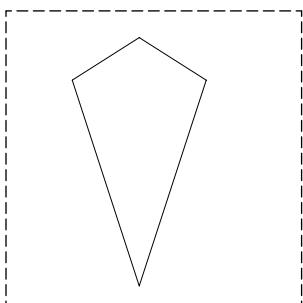

diamante
 $4 \frac{1}{32}'' \times 7 \frac{1}{2}'' \times \frac{3}{8}''$
 coverage: 0.10 sqft/pcs

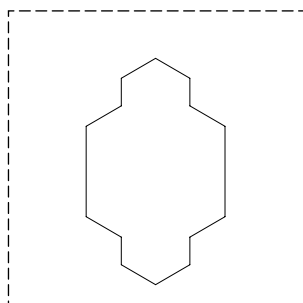

aurora
 $4 \frac{7}{8}'' \times 7 \frac{7}{8}'' \times \frac{3}{8}''$
 coverage: 0.18 sqft/pcs

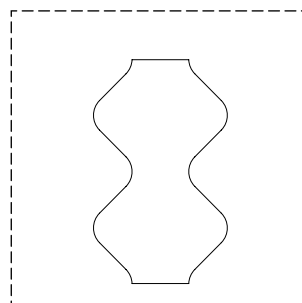

onda
 $5'' \times 8 \frac{9}{32}'' \times \frac{3}{8}''$
 coverage: 0.20 sqft/pcs

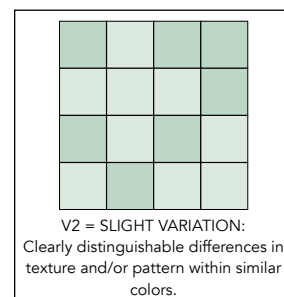

MARBLE SYSTEMS

MID-ATLANTIC & MID-WEST DIVISION

2737 DORR AVENUE FAIRFAX, VA 22031 PHONE : 703 226 1590 FAX : 703 226 1591

NORTHEAST DIVISION

610 WASHINGTON AVE CARLSTADT, NJ 07072 PHONE : 201 507 0111 FAX : 201 507 0888

WEST COAST DIVISION

2111 E HOWELL AVE, ANAHEIM, CA 92806 PHONE : 714 525 8910 FAX : 714 525 8911

MIAMI & CARIBBEAN DIVISION

2716 PONCE DE LEON BLVD. CORAL, GABLES, FL 33134 PHONE : 305 463 9850 FAX : 305 463 9851

SOUTHEAST DIVISION

2010 WEST ATLANTIC BLVD. POMPANO BEACH, FL 33069

PHONE : 954 979 9530 FAX : 954 979 9531

PUERTO RICO DIVISION

279 JOSÉ DE DIEGO AVE. SAN JUAN, PR 00920 PHONE : 787 793 5642 FAX : 787 774 8238

DOMINICAN REPUBLIC

CALLE DR MANUEL EMILIO PERDOMO #33, LOCAL 3 ENSANCHE NACO

SANTO DOMINGO, REPÚBLICA DOMINICANA PHONE: 809 692 2391

COUNTRY FLOORS

NEW YORK

15 EAST 16TH STREET NEW YORK, NY 10003 PHONE : (212) 627 8300 FAX : (212) 242 1604

LOS ANGELES

8735 MELROSE AVENUE LOS ANGELES, CA 90069 PHONE : (310) 657 0510 FAX : (310) 657 2172

SAN FRANCISCO

TWO HENRY ADAMS STREET ST. 100 SAN FRANCISCO, CA 94103 PHONE : (415) 241 0500 FAX : (415) 241 0600

MANUFACTURING FACILITIES

CHANTILLY

25383 PLEASANT VALLEY ROAD, CHANTILLY, VA 20152 PHONE : 703 337 1500 FAX: 703 337 1501

MGM

ORGANIZE SANAYI BOLGESI 1. CD. 12. SK. NO: 8 AFYONKARAHISAR/TURKEY PHONE : +90 541 472 2205

TUREKS

ORGANIZE SANAYI BOLGESI 1. CD. 5. SK. AFYONKARAHISAR/TURKEY PHONE : +90 272 221 1600

